

INN100FQ025A

100V Enhancement-mode GaN Power Transistor

INN100FQ025A

1. General description

GaN-on-Silicon enhancement mode high-electron-mobility-transistor (HEMT) in FCQFN with 3.0 mm x 5.0 mm package size.

2. Features

- GaN-on-Silicon E-mode HEMT technology
- Very low gate charge
- Ultra-low on resistance
- Very small footprint

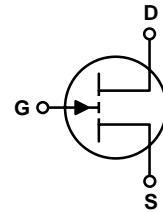

3. Applications

- High frequency DC-DC converter
- BMS protection
- RF envelope tracking
- PC charger
- Mobile power bank
- Motor driver

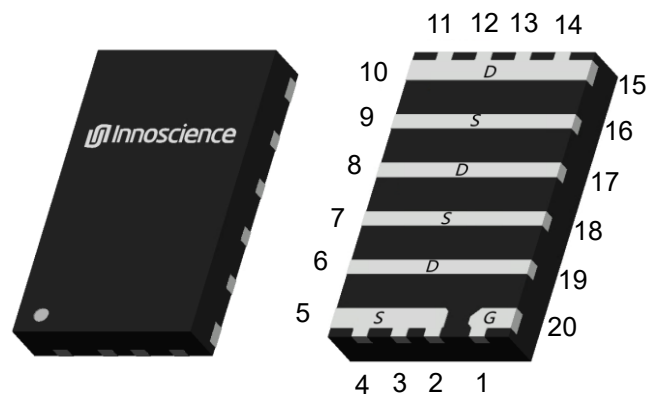

4. Key performance parameters

Table 1 Key performance parameters at $T_j = 25\text{ }^\circ\text{C}$

Parameter	Value	Unit
$V_{DS,max}$	100	V
$R_{DS(on),max}$ @ $V_{GS} = 5\text{ V}$	2.8	m Ω
$Q_{G,typ}$ @ $V_{DS} = 50\text{ V}$	14	nC
$I_{DS,Pulse}$	320	A
Q_{OSS} @ $V_{DS} = 50\text{ V}$	85	nC

5. Pin information

Table 2 Pin information

Pin	Pin description	Pin function
1,20	Gate	Driver Gate
2-5,7,9,16,18	Source	Source
6,8,10-15,17,19	Drain	Power Drain

Table 3 Ordering information

Type/Ordering Code	Package	Product Code
INN100FQ025A	FCQFN 3X5	J22

Table of contents

1. General description	1
2. Features	1
3. Applications.....	1
4. Key performance parameters.....	1
5. Pin information	1
6. Maximum ratings.....	3
7. Thermal characteristics.....	4
8. Electric characteristics	5
9. Electric characteristics diagrams	7
10. Package Outlines	12
11.Reel information.....	13
12.Land pattern	14
13.Revision history	15

6. Maximum ratings

at $T_j = 25\text{ °C}$ unless otherwise specified.

Continuous application of maximum ratings can deteriorate transistor lifetime. For further information, contact Innoscience sales office.

Table 4 Maximum ratings

SYMBOL	PARAMETER	MAX	UNIT
V_{DS}	Drain-to-Source Voltage (Continuous)	100	V
$V_{DS(tr)}$	Drain-to-Source Voltage (up to 300,000 5ms pulse at 150 °C)	120	V
I_D	Continuous current	80	A
	Pulsed (25 °C, $T_{Pulse} = 100\ \mu s$)	320	A
V_{GS}	Gate-to-Source Voltage	6	V
	Gate-to-Source Voltage	-4	V
T_J	Operating Temperature	-40 to 150	°C
T_{STG}	Storage Temperature	-40 to 150	°C

7. Thermal characteristics

Table 5 Thermal characteristics

SYMBOL	PARAMETER	TYP	UNIT
$R_{\theta JC}$	Thermal Resistance, Junction to Case	14.15	°C/W
$R_{\theta JB}$	Thermal Resistance, Junction to Board	1.89	°C/W
$R_{\theta JA}$	Thermal Resistance, Junction to Ambient ¹	61.06	°C/W

Note 1: $R_{\theta JA}$ is determined with the device mounted on one square inch of copper pad, single layer 2 oz copper on FR4 board.

8. Electric characteristics

at $T_j = 25\text{ }^\circ\text{C}$, unless specified otherwise

Table 6 Static characteristics

SYMBOL	PARAMETER	MIN	TYP	MAX	UNIT	TEST CONDITIONS
BV_{DSS}	Drain-to-Source Voltage	100	-	-	V	$V_{GS} = 0\text{ V}$, $I_D = 600\text{ }\mu\text{A}$
I_{DSS}	Drain Source Leakage	-	12	24	μA	$V_{GS} = 0\text{ V}$, $V_{DS} = 80\text{ V}$
I_{GSS}	Gate-to-Source Forward Leakage	-	2.5	9	μA	$V_{GS} = 5\text{ V}$
	Gate-to-Source Reverse Leakage	-	0.3	0.5	μA	$V_{GS} = -4\text{ V}$
$V_{GS(TH)}$	Gate Threshold Voltage	0.8	1.1	2.5	V	$V_{DS} = V_{GS}$, $I_D = 13\text{ mA}$
$R_{DS(on)}$	Drain-Source On-state Resistance	-	2.2	2.8	$\text{m}\Omega$	$V_{GS} = 5\text{ V}$, $I_D = 30\text{ A}$
V_{SD}	Source-Drain Forward Voltage	-	1.5	-	V	$I_S = 0.5\text{ A}$, $V_{GS} = 0\text{ V}$

Table 7 Dynamic characteristics

SYMBOL	PARAMETER	MIN	TYP	MAX	UNIT	TEST CONDITIONS
C _{ISS}	Input Capacitance	-	1500	-	pF	V _{GS} = 0 V, V _{DS} = 50 V
C _{OSS}	Output Capacitance	-	700	-		V _{GS} = 0 V, V _{DS} = 50 V
C _{RSS}	Reverse Transfer Capacitance	-	12.5	-		V _{GS} = 0 V, V _{DS} = 50 V
C _{OSS(ER)}	Energy Related C _{OSS}	-	1150	-		V _{GS} = 0 V, V _{DS} = 0 V to 50 V
C _{OSS(TR)}	Time Related C _{OSS}	-	1600	-		V _{GS} = 0 V, V _{DS} = 0 V to 50 V
R _G	Gate resistance	-	1.8	-	Ω	f = 5 MHz, open drain
Q _G	Total Gate Charge	-	14	-	nC	V _{GS} = 5 V, V _{DS} = 50 V, I _D =30 A
Q _{GS}	Gate to Source Charge	-	2.8	-		V _{DS} = 50 V, I _D =30 A
Q _{GD}	Gate to Drain Charge	-	3	-		V _{DS} = 50 V, I _D =30 A
Q _{G(TH)}	Gate Charge at Threshold	-	1.5	-		V _{DS} = 50 V, I _D =30 A
Q _{OSS}	Output Charge	-	85	-		V _{GS} = 0 V, V _{DS} = 50 V

9. Electric characteristics diagrams

at $T_J = 25\text{ }^\circ\text{C}$, unless specified otherwise

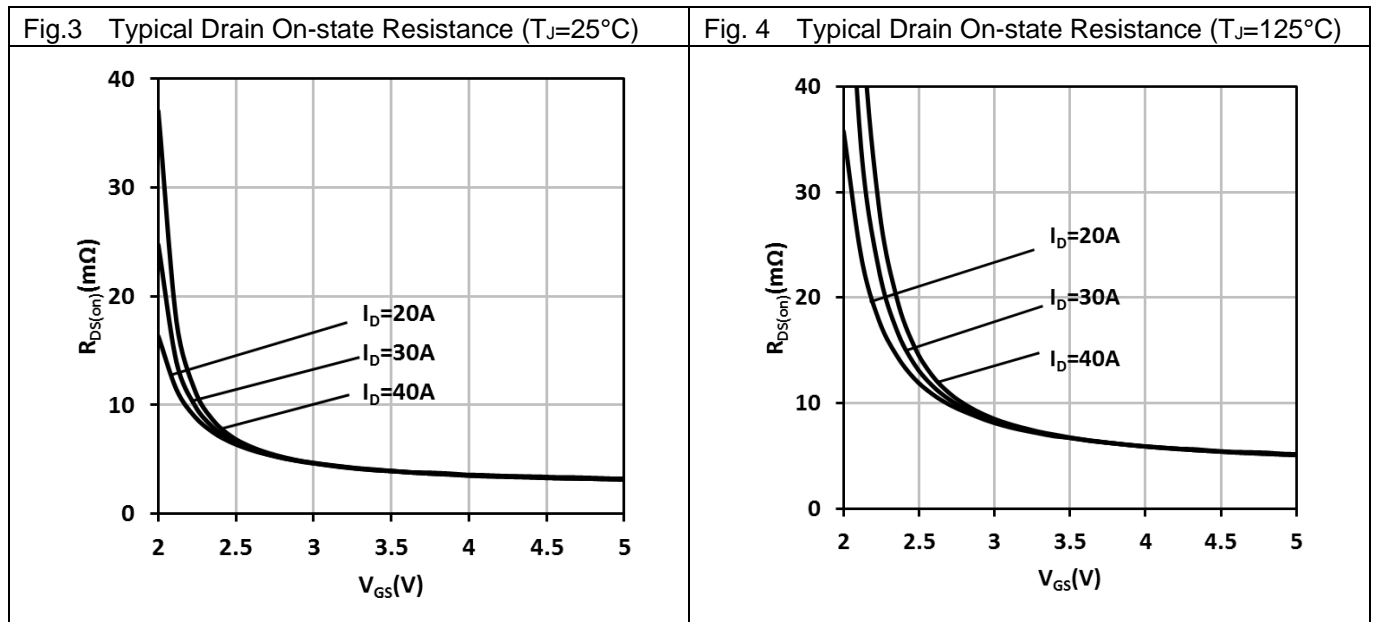
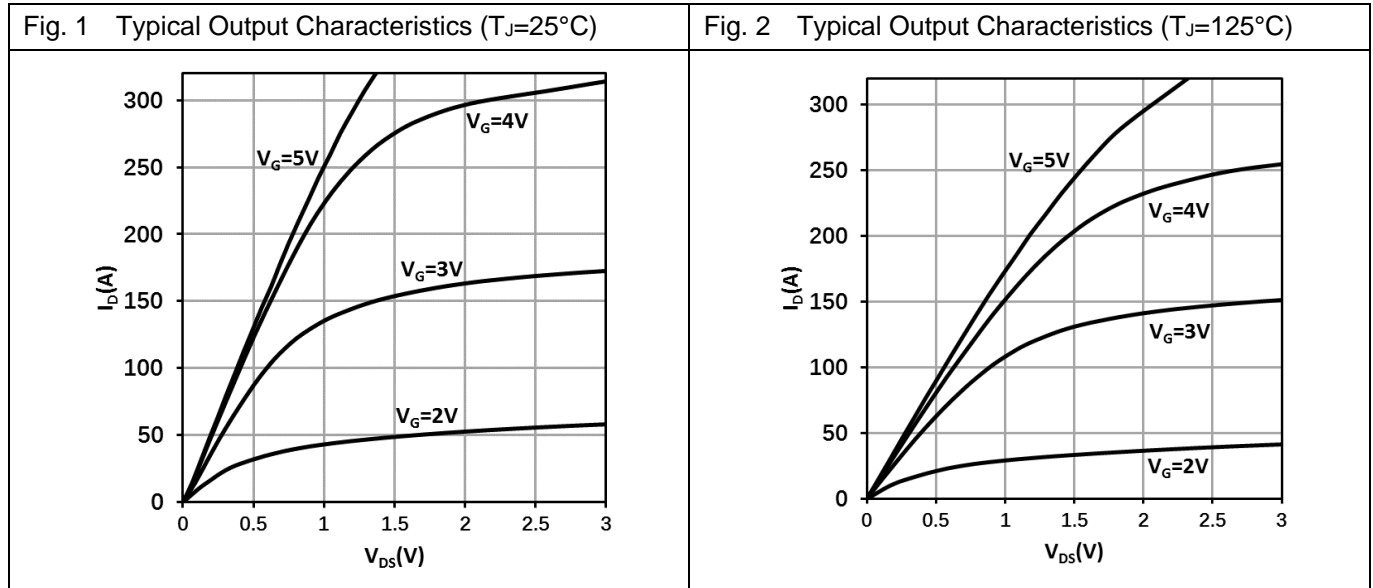

Fig. 5 Normalized On-State Resistance vs. Temp.

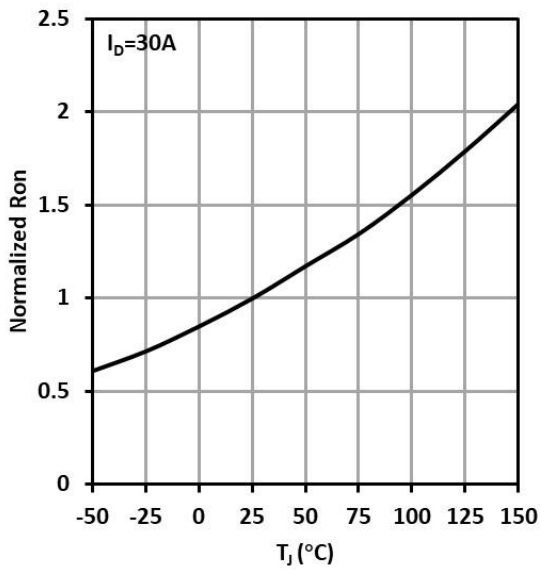

Fig. 6 Typical Transfer Characteristics

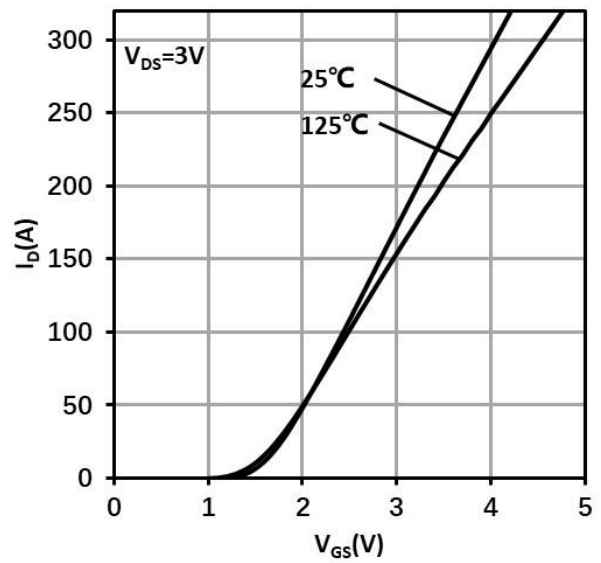

Fig. 7 Typ. Reverse Drain-Source Characteristics ($V_{GS} \leq 0, T_J = 25^\circ\text{C}$)

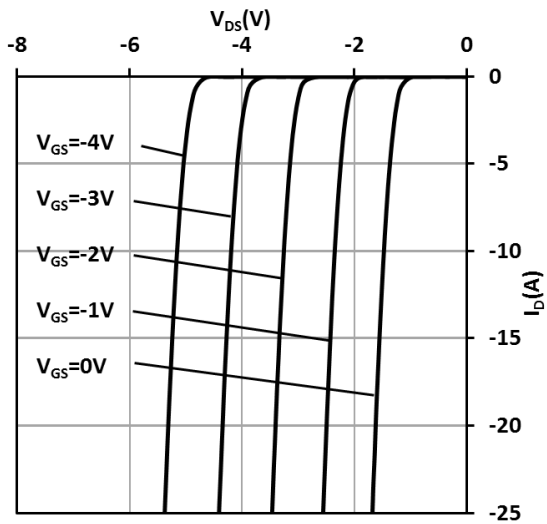

Fig. 8 Typ. Reverse Drain-Source Characteristics ($V_{GS} \geq 0, T_J = 25^\circ\text{C}$)

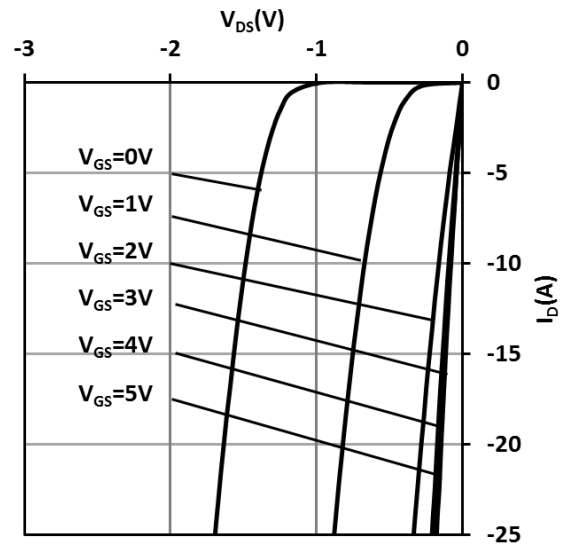

Fig. 9 Typ. Reverse Drain-Source Characteristics ($V_{GS} \leq 0$, $T_J = 125^\circ\text{C}$)

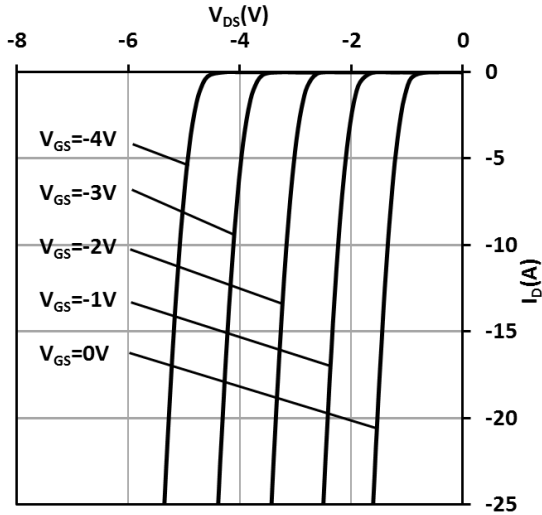

Fig. 10 Typ. Reverse Drain-Source Characteristics ($V_{GS} \geq 0$, $T_J = 125^\circ\text{C}$)

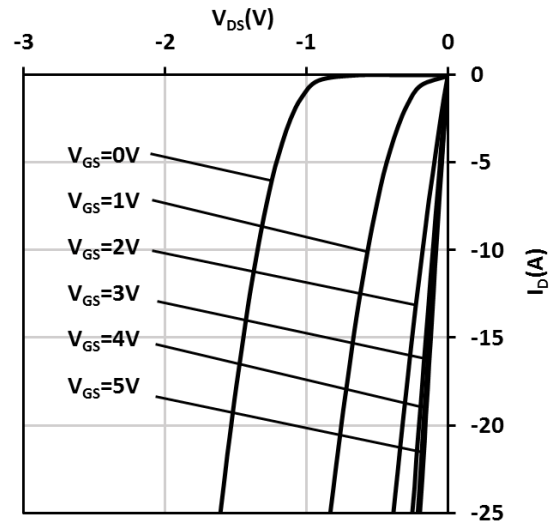

Fig. 11 Typ. Capacitances Characteristics

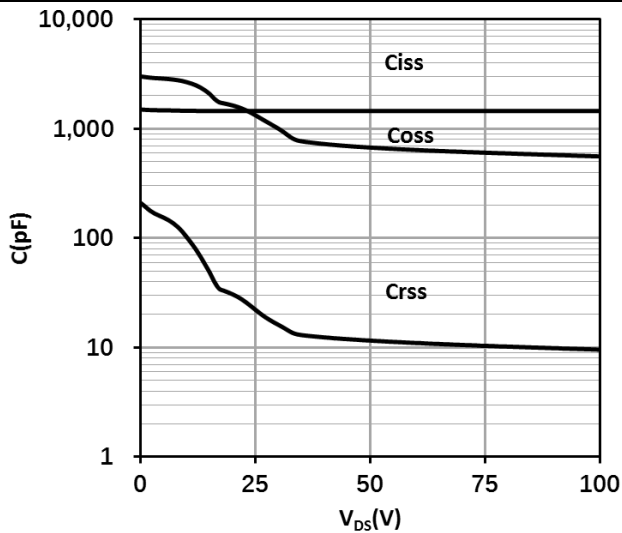

Fig. 12 Typ. Gate Charge

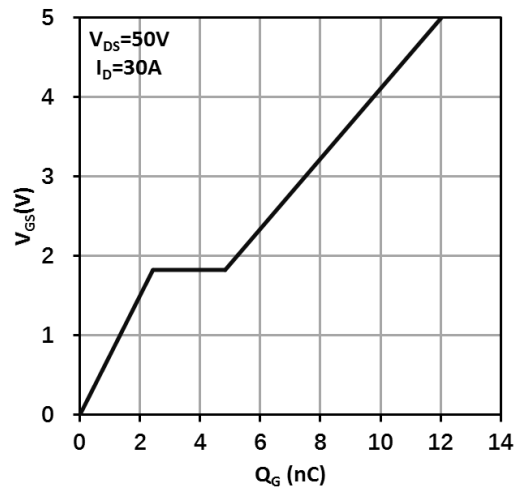

Fig. 13 Normalized Threshold Voltage vs. Temp.

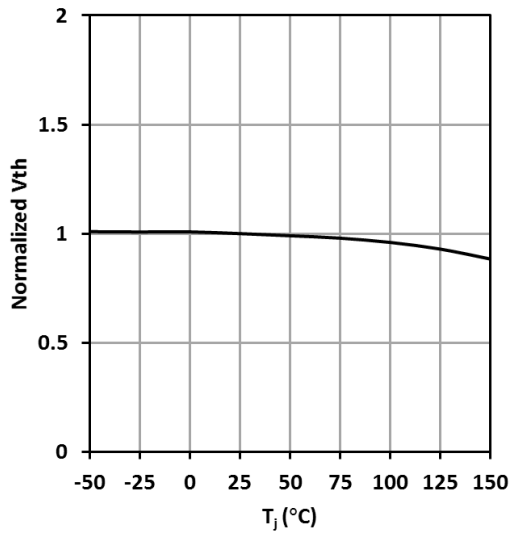

Fig. 14 Output Charge

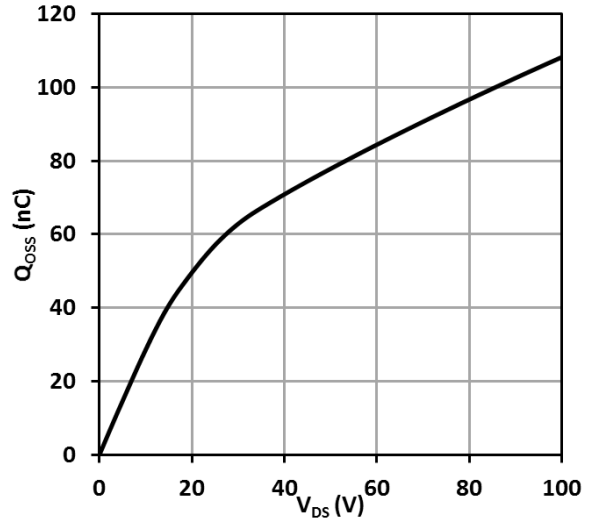

Fig. 15 Output Capacitance Stored Energy

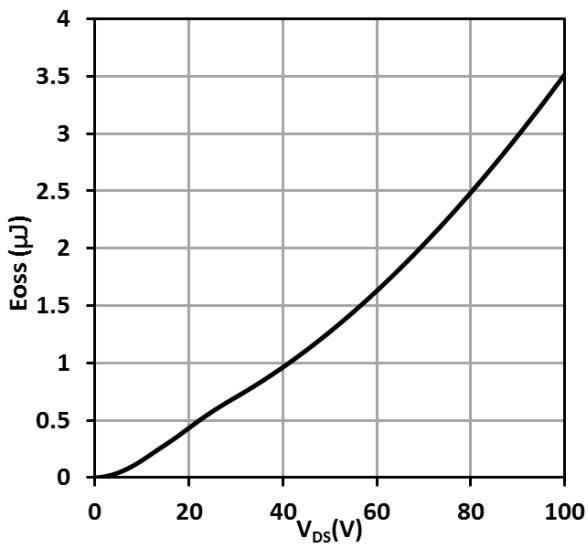

Fig. 16 Power Dissipation

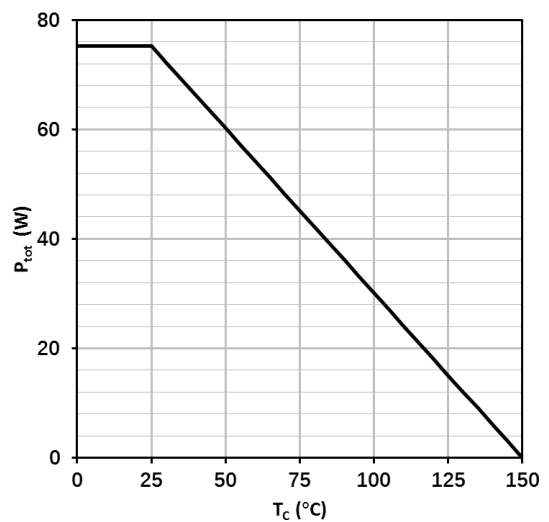

Fig. 17 Safe Operating Area

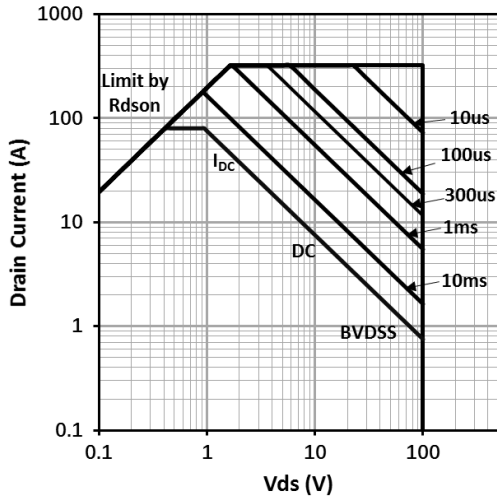
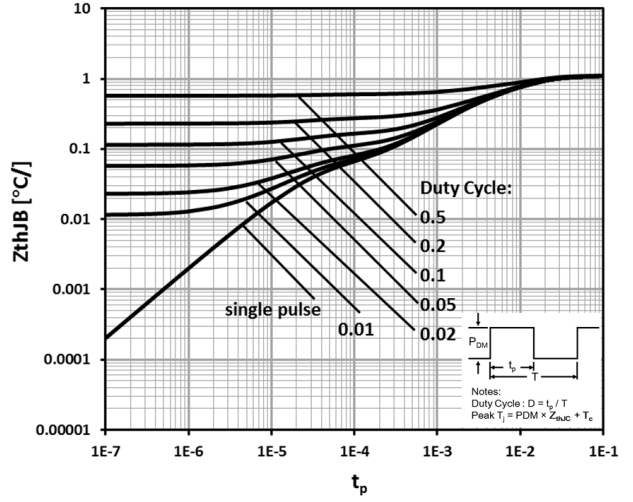
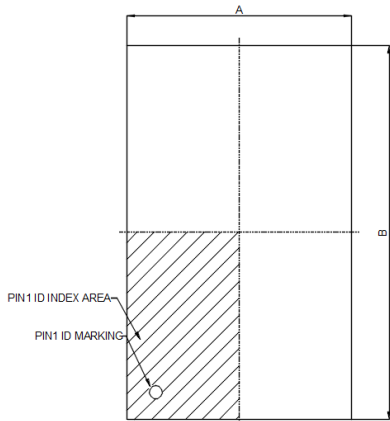

Fig. 18 Max. Transient Thermal Impedance



10. Package Outlines

Package Reference



TOP VIEW

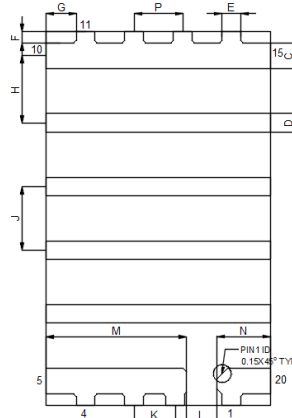

BOTTOM VIEW

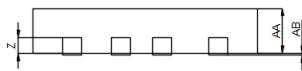

SIDE VIEW

SYMBOL	MILLIMETER			NOTE
	MIN	NOM	MAX	
A	2.90	3.00	3.10	
B	4.90	5.00	5.10	
C	0.30	0.35	0.40	3X
D	0.20	0.25	0.30	4X
E	0.20	0.25	0.30	8X
F	0.15 REF			3X
G	0.40 REF			4X
H	0.90 BASIC			2X
J	0.85 BASIC			3X
K	0.55 BASIC			
P	0.65 BASIC			4X
L	0.35	0.40	0.45	
M	1.775	1.875	1.975	
N	0.625	0.725	0.825	
Z	0.203 REF			
AA	0.65	0.75	0.85	
AB	0.00	0.02	0.05	

NOTE:

- 1) ALL DIMENSION ARE IN MILLIMETERS.
- 2) BOTTOM VIEW IS FT TESTER SIDE VIEW.
- 3) LEAD COPLANARITY SHALL BE 0.08 MILLIMETERS MAX.
- 4) COMPLIES WITH JEDEC MO-220.
- 5) DRAWING IS NOT TO SCALE.

Pin Information

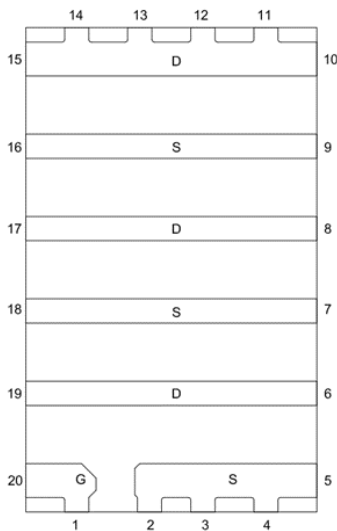

TOP VIEW

Marking Reference :

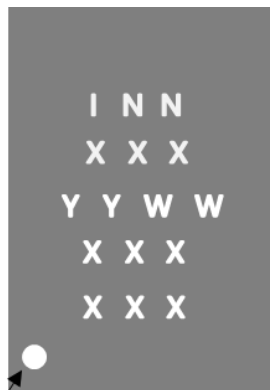

Die Orientation Dot
& Gate Position

Row [↕]	Description [↕]	Example [↕]
Row 1 [↕]	Company name [↕]	INN [↕]
Row 2 [↕]	Product code [↕]	XXX [↕]
Row 3 [↕]	Date code [↕]	YYWW [↕]
Row 4 [↕]	Lot No [↕]	XXX [↕]
Row 5 [↕]	Lot No [↕]	XXX [↕]

11. Reel information

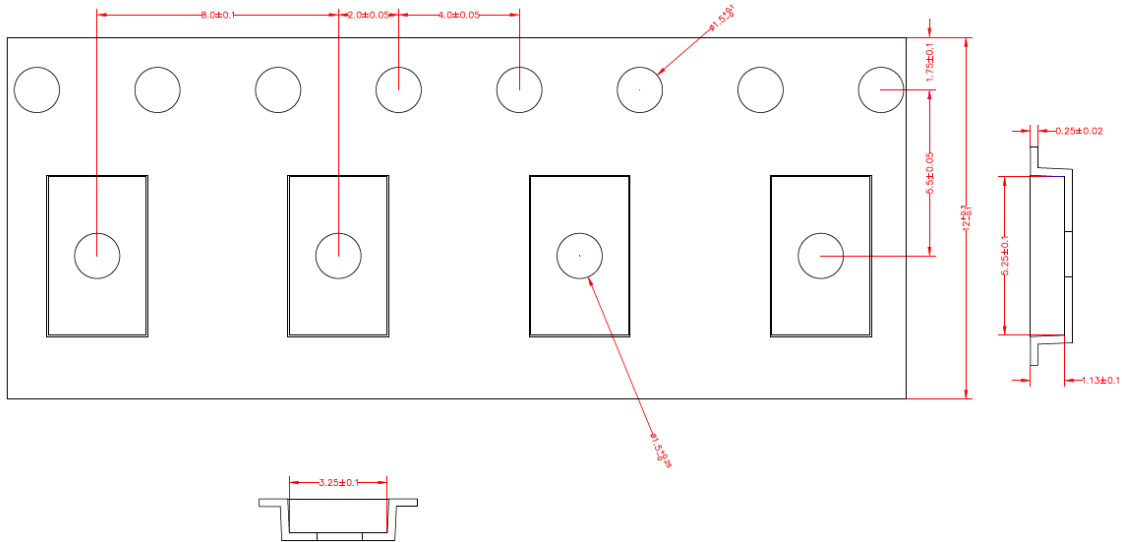

NOTES:

1. CARRIER TAPE COLOR: BLACK.
2. COVER TAPE WIDTH: 9.5±0.10.
3. COVER TAPE COLOR: TRANSPARENT.
4. 10 SPROCKET HOLE PITCH CUMULATIVE TOLERANCE ±0.20 MAX.
5. CAMBER NOT TO EXCEED 1MM IN 100MM.
6. MOLD# 3 X 5 X 0.85
7. ALL DIMS IN MM.
8. BAN TO USE THE ENVIRONMENT-RELATED SUBSANCES OF JCET PRESCRIBING.

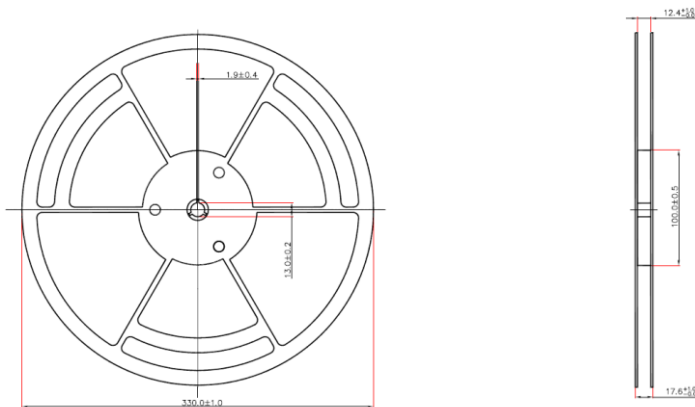

NOTES:

1. COLOR: BLUE.
2. ALL DIM IN mm.
3. GENERAL TOLERANCE±0.25.
4. BAN TO USE THE ENVIRONMENT-RELATED SUBSANCES OF JCET PRESCRIBING.

12. Land pattern

Recommended land pattern

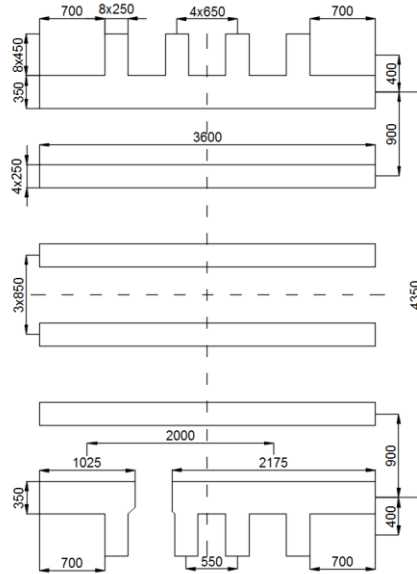

Unit: μm

TOP VIEW

Recommended Stencil drawing

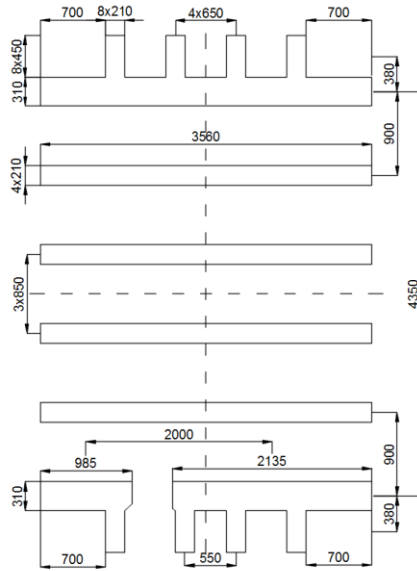

Unit: μm

TOP VIEW

13. Revision history

Major changes since the last revision

Revision	Date	Description of changes
1.0	2023-07-19	Version 1.0 release
1.1	2023-09-26	Version 1.1 release, add $V_{DS(tr)}$ in Table 4

Important Notice

The information provided in this document is intended as a guide only and shall not in any event be regarded as a guarantee of conditions, characteristics or performance. Innoscience does not assume any liability arising out of the application or use of any product described herein, including but not limited to any personal injury, death, or property or environmental damage. No licenses, patent rights, or any other intellectual property rights is granted or conveyed. Innoscience reserves the right to modify without notice. All rights reserved.